

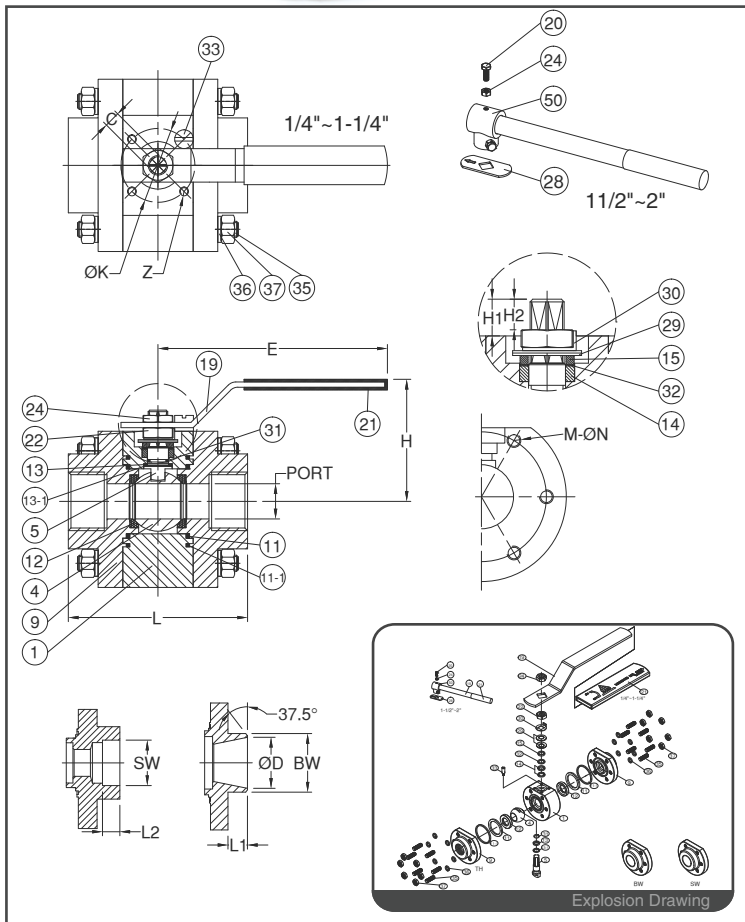

CRN
CERTIFICATED



FEATURES

- Full Bar Machined Construction
- 3 Pieces Body Design
- High Pressure Design
- ISO 5211 Mounting Flange
- Blow-Out-Proof Stem Design & Anti-Static Device
- Available for Pneumatic or Electric Actuator
- NACE MR0175 is available upon request
- Super Alloy materials for highly corrosive medium are available upon request

AUTOMATION
AVAILABLE

SPECIFICATIONS

- Size Range 1/4" ~ 2" (DN8 ~ DN50)
- End Connection Threaded / Socket / Butt Weld Ends
- Working Pressure 3000PSI / PN210 (CWP)
- Steam Pressure 150 PSIG. Saturated Steam for RTFE.
- Temperature Range -4 to 356 °F (-20 to 80 °C) for DELRIN
-4 to 356 °F (-20 to 250 °C) for PEEK

STANDARDS

- Design ASME/ANSI B16.34
- Threaded End NPT/ BS 21 (BSP) / BSPT / ISO 228-1 / DIN 2999 / ISO 7-1Rp
- Socket Weld End ASME/ANSI B16.11
- Butt Weld End ASME/ANSI B16.25
- Face to Face MFG Standard
- Material AISI
- Pressure Testing API 598

CERTIFICATE

- Fire Safe API 607 5th Edition / ISO 10497-5
- Quality Assurance ISO 9001
- Material Certificate EN 10204-3.1 MTR
- CE Approval PED 97/23/EC Module H
- Canadian Certificate CRN

MATERIAL LIST

NO.	PART NAME	MATERIAL (more options available)
1	BODY	AISI 316 / AISI 1045
4	BALL	ASTM A351 Gr.CF8M
5	STEM	17-4 PH
9	END CAP	AISI 316 / AISI 1045
11	BODY SEAL	GRAPHITE
11-1	BODY SEAL	PTFE
12	SEAT	DELRIN® / PEEK
13	THRUST WASHER	GRAPHITE
13-1	THRUST WASHER	PTFE
14	STEM PACKING	GRAPHITE
15	GLAND BUSH	SS304
19	HANDLE	SS304
20	HANDLE BOLT	SS304
21	HANDLE COVER	PLASTIC
22	STEM NUT	SS304
24	HANDLE NUT	SS304
28	STOP PLATE	SS304
29	BELLEVILLE WASHER	SUS304-CSP
30	TAB WASHER	SS304
31	O-RING	VITON®
32	PACKING FOLLOWER	TFM™1600
33	STOP PIN	SS304
35	BODY BOLT	SS304 / SCM440
36	BODY WASHER	SS304 / S45C
37	BOLT NUT	SS304 / S45C
50	HANDLE ADAPTER	ASTM A351 Gr.CF8

DIMENSION

																	unit : mm			
SIZE	PORT	L	L1	L2	E	H	H1	H2	C	M	ØN	ØK	Z	SW	ØD	BW				
DN8	1/4"	9.5	85	13	10	151	61	12.6	7.0	9	4	5/16"-18UNC	36	F03	M5	14.0	9.2	13.7		
DN10	3/8"	11.6	85	13	10	151	61	12.6	7.0	9	4	5/16"-18UNC	36	F03	M5	17.6	12.5	17.1		
DN15	1/2"	12.5	85	13	10	151	61	12.6	7.0	9	4	5/16"-18UNC	36	F03	M5	21.7	15.8	21.3		
DN20	3/4"	16.0	89	13	13	151	67	19.55	10.3	9	4	5/16"-18UNC	42	F04	M5	27.3	20.9	26.7		
DN25	1"	20.0	102	17	13	183	81	16.4	10.0	9	6	5/16"-18UNC	42	F04	M5	33.9	26.6	33.4		
DN32	1-1/4"	25.0	111	20	13	183	95	24.05	13.3	11	6	5/16"-18UNC	42	F04	M5	42.8	35.1	42.2		
DN40	1-1/2"	32.0	119	20	13	285	113	34.5	17.5	14	6	3/8"-16UNC	50	F05	M6	48.7	40.9	48.3		
DN50	2"	38.0	126	20	16	285	117	32.1	17.5	14	6	1/2"-13UNC	50	F05	M6	61.0	52.5	60.3		

DIMENSION

																	unit : inch			
SIZE	PORT	L	L1	L2	E	H	H1	H2	C	M	ØN	ØK	Z	SW	ØD	BW				
DN8	1/4"	0.37	3.35	0.51	0.39	5.94	2.40	0.50	0.28	0.35	4	5/16"-18UNC	1.42	F03	M5	0.55	0.36	0.54		
DN10	3/8"	0.46	3.35	0.51	0.39	5.94	2.40	0.50	0.28	0.35	4	5/16"-18UNC	1.42	F03	M5	0.69	0.49	0.67		
DN15	1/2"	0.49	3.35	0.51	0.39	5.94	2.40	0.50	0.28	0.35	4	5/16"-18UNC	1.42	F03	M5	0.85	0.62	0.84		
DN20	3/4"	0.63	3.50	0.51	0.51	5.94	2.64	0.77	0.41	0.35	4	5/16"-18UNC	1.65	F04	M5	1.07	0.82	1.05		
DN25	1"	0.79	4.02	0.67	0.51	7.20	3.19	0.65	0.39	0.35	6	5/16"-18UNC	1.65	F04	M5	1.33	1.05	1.31		
DN32	1-1/4"	0.98	4.37	0.79	0.51	7.20	3.74	0.95	0.52	0.43	6	5/16"-18UNC	1.65	F04	M5	1.69	1.38	1.66		
DN40	1-1/2"	1.26	4.69	0.79	0.51	11.22	4.45	1.36	0.69	0.55	6	3/8"-16UNC	1.97	F05	M6	1.92	1.61	1.90		
DN50	2"	1.50	4.96	0.79	0.63	11.22	4.61	1.26	0.69	0.55	6	1/2"-13UNC	1.97	F05	M6	2.40	2.07	2.37		